

A 9

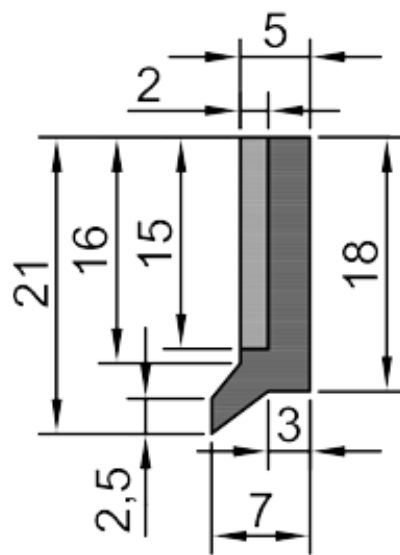

mm. 560